



USER MANUAL

Air purifier ALR300 Comfort

!!! PLEASE NOTE !!!

Before using first remove the foil packing form the filters inside.



Thank you for purchasing this product. The air purifier is fitted with high efficiency filters, equipped with energy-efficient and cutting-edge technology.

To get familiarized with your new product, please read the manual carefully before first use and retain this booklet for future reference.

Some housing parts, such as the keypad and the black front area, are provided with protective foils to prevent scratching. Please do not remove these protective foils unless you are sure that you will keep the air purifier.

Service-adress

alfda Artikel für Allergiker Handels-GmbH
Wörth 19
DE-94034 Passau
Tel.: +49 (0) 851 - 85 16 38 - 88
Fax: +49 (0) 851 - 85 16 38 - 30
eMail: verkauf@alfda.de
Internet: www.alfda.de
WEEE-Reg.-Nr.: DE 87819261

!Please note on initial operation due to cold temperatures!
Place the air purifier in a heated room for 2-3 hours before turning on the device for the first time. This will allow the engine oil to adjust itself to room temperature, so that noises will be avoided.

Table of contents

Serviceaddress.....	Page 1	7. Operation.....	Page 4-5
1. Short notes for use.....	Page 2	8. Filter installation.....	Page 6
2. Safety instructions.....	Page 2	9. Maintenance.....	Page 6
3. Technical specifications.....	Page 2	10. Filter replacement.....	Page 6
4. Filter structure.....	Page 3	11. Failure and Solutions.....	Page 7
5. Placement.....	Page 3	12. Warranty conditions.....	Page 7-8
6. Components.....	Page 4	13. Information of proper disposal.....	Page 8

1. Short notes for the use

The air purifier alfa ALR300 Comfort is easy to use. In addition to the built-in timer function, it can be controlled with an external conventional time switch, to turn it on or off.

For effective air cleaning, we recommend to proceed as follows:

- Ventilate extensively 2 - 3 times daily, and then turn on the air cleaner.
- In order to achieve an optimal air cleaning, the air cleaner should be operated as long as necessary to achieve twice the purification of the room air volume.

Examples for running times:

Room size	minimum running time	fan speed
~12 m ² / 30 m ³	~ 50 Min.	1 (low)
~12 m ² / 30 m ³	~ 10 Min.	3 (high)
~20 m ² / 50 m ³	~ 70 Min.	1 (low)
~20 m ² / 50 m ³	~ 20 Min.	3 (high)
~40 m ² / 100 m ³	~ 70 Min.	2 (medium)
~60 m ² / 150 m ³	~ 60 Min.	3 (high)



Additionally, you can use the air purifier in automatic mode.

Using in a sleeping room: We recommend a time limited running with high fan speed after airing of the room and before going to bed. If necessary, you can use the sleep mode the entire night. The window can remain open. In the case of pollen, place the air cleaner between the open window and the bed area.

We recommend using the ionization only for a short time in the sleeping area, as this can cause poor sleep for sensitive people.

2. Safety instructions

- Please unpack the filter before use, otherwise there will be no filter effect and the air purifier can also be damaged!
- Never block the air intake and the air outlet of the unit.
- Do not place the air purifier nearby heaters, stoves, etc. and avoid grease aerosols, heat and water splashes in and near the unit.
- Please unplug the power cord when the unit is not used for a long time.
- To clean the housing do not use water or detergent to avoid damage.

3. Technical Data *)

Model	ALR300 Comfort
Voltage	220-240V 50 Hz
Power ca.	Max. 35 Watt
Power Standby	0,7 Watt
Air volume Sleep / min./ medium / max. ca.	55 / 80 / 170 / 300 m ³ /h
Noise level Sleep / min./ max. ca.	16 / 18 / 55 dB(A)
Net weight ca.	7,5 kg
Dimensions (L x B x H)	335x220x570 mm
Cabel length ca.	1,8 m
Insulation	Protection class II
Applicable area optimal / maximal	Up to 40 m ² (100 m ³) / up to 60 m ² (150 m ³)

*) based on unused alfaCleanAIR filter.

4. Filter structure

- **Low-mashed plastic pre-filter** to filter coarse particles, fluffs and hair.....**Part.-No.:155610**



Filter element alfdaCleanAIR (Standard-version).....Part.-No.:155611

Consisting of **blue textil pre-filter** (cotton) to filter coarse dust, **HIMOP-filter** (High Efficiency Multi oxidation pottery and Porcelain Granule Efficiency Particulate Airfilter): with high filter-performance. • **HEPA filter** (High Efficiency Particulate Airfilter): of high efficiency. Removes smoke and dust of 0,3 µm. The filtrating rate is as high as 99%.



Filter element alfdaAntiSMOKE (alternative 1).....Part.-No.:155612

Consisting of black **textile pre-filter** (cotton) to filter coarse dust, **HEPA-Active-Carbon-Special-filter** with high storage capacity for harmful gas, smoke and odors. Filtration rate: > 99,5% for charges up to 0,1 µm according to EN 1822-1:2009



Filter element alfdaTrueHEPA (alternative 2)

Consisting of 2 filter-sets

FILTER ELEMENT 1.....Part.-No.:155613

The green textile pre-filter (cotton) to filter coarse dust and with additional antibacterial effect, the fine dust filter for filtering dust and allergen load.

Filtration rate: 90-95% with up to 0,4 µm particle size.

FILTER ELEMENT 2.....Part.-No.:155614

The HEPA-Filter (High Efficiency Particulate Airfilter): with high filter-performance of suspended matter and finest particles/allergens. Filtration rate: > 99,95 % for charges up to 0,1 µm according to EN 1822-1:2009

- **Ionizer (could be switched ON / OFF):** To generate negative charged ions (capacity: 3.000.000 / cm³) and to refresh indoor air.
- **Dunen-filter – Additional-filter (optional).....Part.-No.:155609**
Consisting of a washable special-filter-fleece which filtrates bird-feather-dust and protects the main filter element.

5. Placement

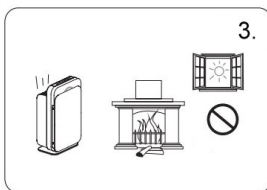
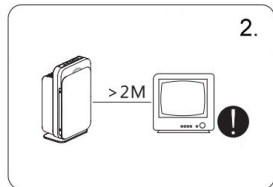
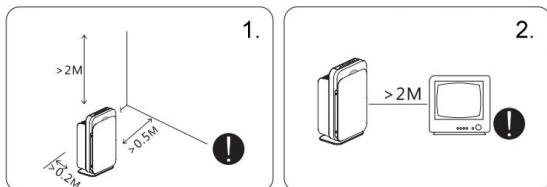

1. Keep at least 20 cm distance to the wall, 50 cm distance to the air inlets and 2 m distance to the ceiling.
2. Keep 2 m distance to any Multi-Media-Products.
3. Do not place the air purifier directly into the sun. The air purifier does not replace the necessary ventilation (oxygenation) especially in rooms with fireplaces.
4. **Important: The air purifier is not suitable to filter greasy air! It is not suitable to be placed in production areas!**
5. To ensure the best possible air cleaning, the room layout has to be taken into consideration when placing the air purifier.

Following some samples for placing the air purifier:

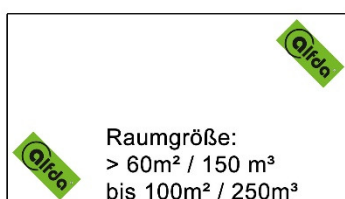
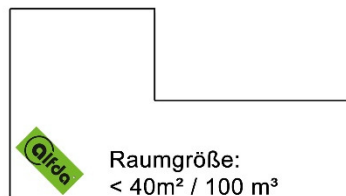
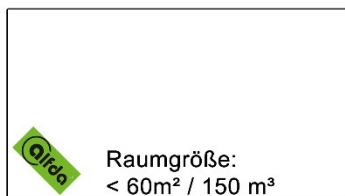

If the room size is larger than 60 m² / 150 m³ or the room is very winding, you may need to place 2 air cleaners.

To get the best result of air cleaning, place the unit where air circulation is good and place the unit near the source of polluted air.

6. Components

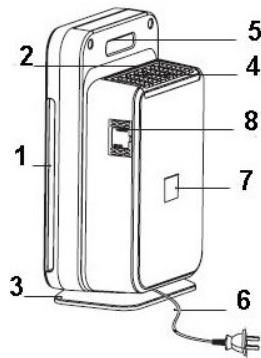

- (1) Air inlet
- (2) Air outlet
- (3) Pedestal / Base
- (4) Ionizer
- (5) Carrying handle
- (6) Power cord
- (7) Label
- (8) PM 2.5 Dust sensor

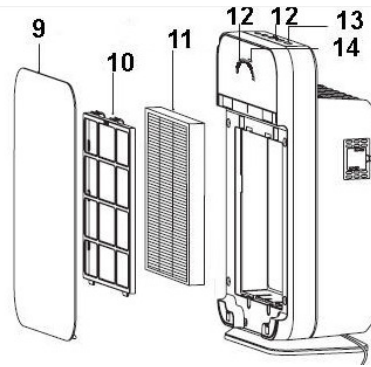

- (9) Front panel
- (10) Plastic Pre-Filter
- (11) Filter-Set (blue-cotton-filter-HIMOP-HEPA-filter)
- (12) Air quality indication
- (13) Operation panel
- (14) IR-Sensor for remote control

Operation panel on top of the unit:

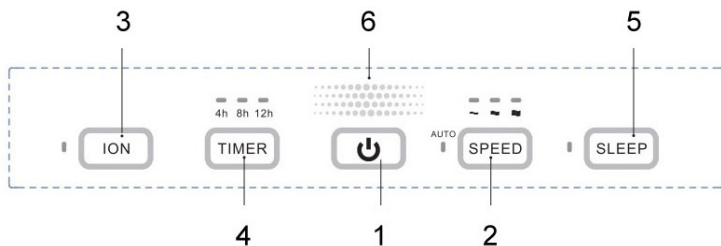

- (1) On / Off
- (2) Fan speed / Auto
- (3) Ionizer On / Off
- (4) Timer function
- (5) Sleep-Mode
- (6) Air quality indication

7. Operation

Method of Operation

Connect the power cord: Once the power cord is connected, the unit starts to work in medium-fan-mode, the ionizer is turned off, the LEDs light up briefly and the particle sensor is activated.



On / Off-button: Pressing the power button, the unit will be switched off/on.

If the unit is switched on again, the last selected mode will be activated and can be changed then.



Fan Speed-button: Press the button for selection of the fan speed. The LED screen will indicate one sign for low speed, two for medium and three for high and a sign for the PM 2,5 -Sensor-controlled automatic operation.



Press the button to use the **timer function**. According to your selection, the air cleaner will run for 4, 8 or 12 hours. The Timer-Function can be combined with all other functions.

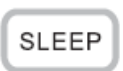

If the **Sleep-Mode** is selected, the air cleaner works very silently with reduced air quantity. All LEDs will be switched off after 10 seconds, except the one indicating the sleep mode, so that the LEDs do not interfere in a dark room. The sleep-Mode can be combined with timer-function and / or ionizer. By pressing any button, the sleep-mode will be switched off.



Press the button for Ionizer. The LED will show the operation.

External timer: The air cleaner can be connected with external timer to set the working time. The unit has to be switched on. The initial mode will be medium-fan-speed with switched off ionizer. The external timer is not included in scope of delivery.

Air quality indication and AUTO-Mode with intelligent PM 2.5 - Sensor Control

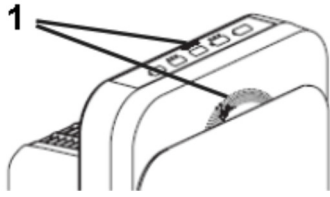

1. The air purifier measures the air quality by using an intelligent dust sensor and displays it in color:
blue = clean air
yellow = deterioration of air quality
red = high air pollution

Using the automatic mode, the air purifier runs permanently in a small fan speed. If air quality degradation is detected it would change automatically in higher fan speed for short time to ensure best air quality.

That, what is known as fine dust (PM_{2.5}) contains 50% of the particles having a diameter of 2.5 microns, a higher proportion of smaller particles and a lower proportion of larger particles. Particles of this size can go into the pulmonary alveoli (lungs). They are at most as large as bacteria and therefore cannot be seen with the naked eye.

The air quality assessment already takes into account the limit values of directive 2008/50/EG as of 2020. That means, that the PM 2.5 value will be below 20 ug / m³ for the indication of clean air (blue)

Remote control

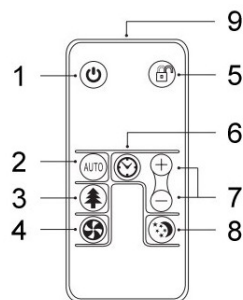

- (1) On / Off Button
- (2) Auto-Mode
- (3) Ionizer On / Off
- (4) Fan speed
- (5) No function
- (6) Timer-function
- (7) Timer-time selection
- (8) Sleep-Mode
- (9) IF-Transmitter

Using the remote control

The functions are identical to the operating modes to be set via the function buttons on the device. Point the remote control at the front of the air purifier and select the desired setting.

8. Filter installation

Before using the air cleaner the first time, remove the foil packing from the filters inside.



1. Remove the front panel as shown

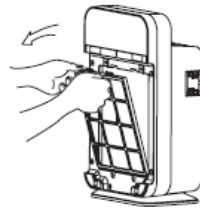

2. Pull down both mounts of the pre-filter to remove it.

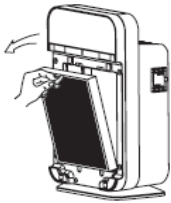

3. Remove the filter-set as shown and remove the foil packing.

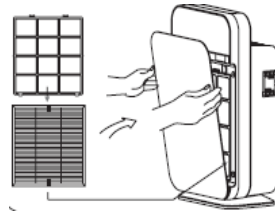

4. Replace the filter element, with a view to the cotton-filter (blue, black or green) and attach the front panel. **Note:** If the front panel is not installed correctly, the air purifier cannot be switched on.

Built in filters

The built in filters consist of a plastic-pre-filter and the main filter elements. (Please refer to Point 4).

9. Maintenance

For maintenance please disconnect the unit from power to avoid an electric shock. Never clean the filters with water to avoid changes to the shape of the filters. The pre-filter and the blue cotton filter should be cleaned carefully with a vacuum cleaner every 4-6 months.

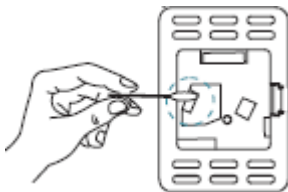

The sensor for air quality measurement has to be cleaned about every 3-6 weeks. To do this, carefully remove the cover and clean the sensor with a clean water moistened swab. Please do not use alcohol or other cleaning agents, as this could damage the sensor.

10. Filter replacement

The plastic pre-filter can be used permanently, however if it is damaged, then it needs to be replaced.

The average durability of the multi-filter is up to 1.5 years with a daily 4-hour operation. The extent of use and air pollution. Strong tobacco smoke for example will shorten the using time of the filter.

If the unit is not used for a long time, we recommend removing the filter from the unit and placing it inside an airtight foil.

Please note that the alfaAntiSMOKE-Filter element loses its effect in case of non-use. Therefore it should be used latest after 2 month of purchase.

The maximum odor and pollutant-filtering effect of the alfaAntiSMOKE-Filter element is 1 year after unpacking the filter.

Replacement filters are available on: www.allergiker-shop-alfda.de

The corresponding part numbers you can find on page 3 / point 4 (Filter Construction)

11. Failure and Solutions

Please refer to the following before contacting Customer Service Centre for service / repair:

Unit does not work: Check if the power cord is plugged in correctly, power is available and the front panel is installed correctly.

The Remote Control does not work: Please check whether the battery is placed correctly and has enough capacity. First try changing the battery (size CR2032). The remote control must be directed at the unit's front side with the IF-Sensor.

The unit is noisy: Check if the foil on the filter is still inside and remove it. Also check the pollution level of the filter-element. A polluted filter can also be the reason for more loudness.

Reduced air flow at the air outlet: Please make sure that the air outlet is not blocked. The filter element is increasingly saturated by particles, dust and allergens and should then be replaced.

Odors or dirt in the air are not being filtered. Loud operation noise level:

Please make sure, that air intake and air outlet are not blocked and clean them carefully with a vacuum cleaner. Take the filter unit out of the air cleaner and clean the pre-filter und filter-set carefully with a vacuum cleaner or replace the filter-set with a new one.

Using the alfaCleanAIR-Filter element: There is the possibility to reactivate the HIMOP filter (odor filter) - Please remove the textile pre-filter and place the filter element in the sunlight for several hours. **NOTE:** The dark side has to be upwards. Hereby the function of the HEPA-Filter is not affected, also the durability is not extended.

Using the alfaTrueHEPA-Filter element: Only particle-borne odors can be filtered, gaseous odors remain unfiltered. If necessary please use the alfaCleanAIR-Filter element or the alfaAntiSMOKE-Filter element.

In case of no improvement, the filter element has to be replaced

The air quality indicator is not working or constantly shows "red": Clean the dust sensor carefully as described before. Please note that this sensor detects only the health concern particles (PM 2.5) and therefore does not respond to any dust. (However, this does not diminish the power of the air cleaning over the entire particle size range.)

12. Warranty conditions

Our products are subject to strict quality control. If your air purifier should still not be functioning properly, we regret this and ask you to contact the authorized customer service.

The warranty period is 2 years from date of purchase. The guarantee is for the country to which the air purifier was delivered from the dealer. Devices, that have material and workmanship defects are repaired or replaced at our discretion during the warranty period. Exchanged devices or parts of devices become our property. It does not extend the warranty period nor does it initiate a new warranty in transition.

Warranty claims must be submitted immediately after becoming aware of the defect within the warranty period.

In order to claim the warranty service involves the following steps:

Please contact by e-mail (verkauf@alfda.de) the customer service and describe the problem. Please note the invoice number and your name in this e-mail.

If a return is agreed upon, send the unit securely packaged at your expense to our service. Include a copy of the invoice on which you note the defect. If the defect is under our guarantee, you will get a repaired or new device sent on our costs.

Warranty claims are excluded for damage caused by:

- Misusage or improper treatment
- Unusable conditions (moisture, fat, heat, over voltage, dust, etc.)
- Failure to follow the safety precautions applicable to the device
- Not following the instructions
- The use of force (eg. drop, shock, impact, dump down, etc.)
- Procedures that were not performed by the address of our authorized service
- Unauthorized attempts to repair
- Unsecure and non-transportable packaging.

Furthermore, no subject to any warranty are batteries and filter cartridges as these are consumable parts.

Defects or damage to the device not covered (or no longer) by the warranty will be corrected if necessary, against costs. For an individual quotation, please contact our customer service.

In this case the shipping costs are at your expense.

© Händlerbund e.V. (erstellt von Rechtsanwalt Andreas Arit, Stand: 12.12.2011)

13. Information of proper disposal

Old electronic equipment is no household waste!

In accordance with Directive 2002/96/EG and national laws, electrical and electronic equipment must be separated from general household waste using the sites designated by local authorities. This can be done by returning the product when purchasing a similar device or by sending it to an authorized collection point for the reprocessing of WEEE. Please discard batteries from the remote control as follows:

Notes on Battery Disposal

In connection with the sale of batteries or with the delivery of equipment containing rechargeable batteries, we are obliged to draw your attention to the following:

As an end-user, you are legally obliged to return used batteries. You can return waste batteries that we carry in stock or have had in the past, free of charge to our warehouse (Wörth 19, 94034 Passau).

The symbols shown on the batteries have the following meaning:

The symbol of the crossed out wheeled bin indicates that the battery should not be treated as household waste.

Pb = battery contains more than 0.004 percent lead

Cd = battery contains more than 0.002 percent cadmium

Hg = battery contains more than 0.0005 per cent of mercury.

Please note the above instructions.



Address:

alfda Artikel für Allergiker Handels-GmbH
Wörth 19
DE-94034 Passau

Contact:

Telefon: +49 (0) 851 - 85 16 38 - 88
Telefax: +49 (0) 851 - 85 16 38 - 30
E-Mail: verkauf@alfda.de

